

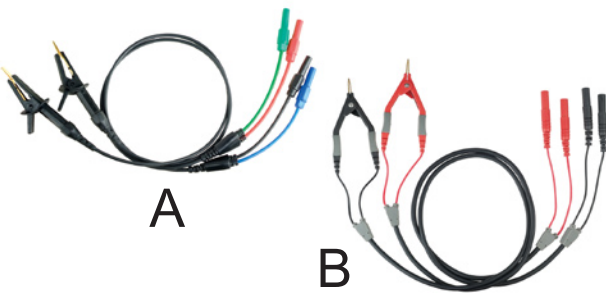

TEST LEADS

TEL-4136C



- **Model Name : Kelvin clip test leads**
- **Wire :**
Length : 700±30mm
PVC insulated wire (60mm) with connected
Straight input plugs (10mm silicon wire)
Out diameter : 4mm
- **Input plug color : Red•Green•Black•Blue**

TEL-EL



- **ELCB Test leads**

AL-52F series



- **Terminal : 4mm banana plug**
- **Wire: PVC UL 1803 or silicone**
Length : 1100±30mm
Out diameter: 4mm
Braid copper wires (170 of 0.08mm)
- EN 61010-031:2002+A1:2008
CAT IV 690V 2A/ CAT IV 500V 10A/ CAT IV 250V 10A
- Remove test lead cap for attaching alligator clips

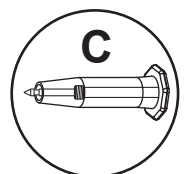
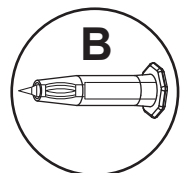
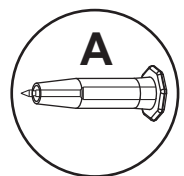
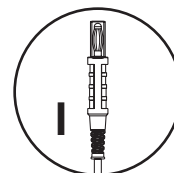
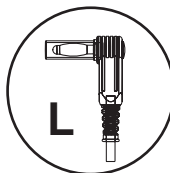
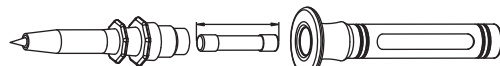

Model	Terminal	Tip	wire material	Fuse rating
AL-52FP-L-2	L	A	PVC	250V:0.1~10A
AL-52FP-L-4	L	B	PVC	500V:0.1~10A
AL-52FP-L-2-4	L	C	PVC	690V:0.1~2A
AL-52FP-1-2	I	A	PVC	
AL-52FP-1-4	I	B	PVC	
AL-52FP-1-2-4	I	C	PVC	
AL-52FPS-L-2	L	A	Silicone	
AL-52FPS-L-4	L	B	Silicone	
AL-52FPS-L-2-4	L	C	Silicone	
AL-52FPS-1-2	I	A	Silicone	
AL-52FPS-1-4	I	B	Silicone	
AL-52FPS-1-2-4	I	C	Silicone	



STANDARD

測試線(Test Leads)

INTRODUCTION



接頭保護套採取螺旋紋設計，使塑膠內的芯線受力不再集中一點，而且由於塑膠螺旋紋抵銷大部分的受力，芯線不易扭斷、折斷，延長了使用壽命，此項產品獲得美國、德國、中國...等多國專利權，並且在國內外市場獲得優良的口碑。

專利號碼

中國(CHINA) ZL 99 2 16904.6

德國(GERMANY) 29912812.1

美國(U.S.A) US 6,265,668 BI

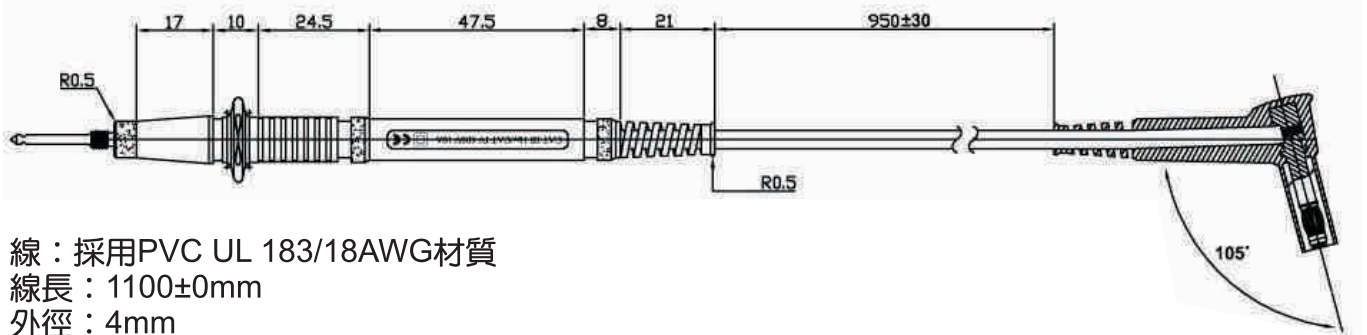

- 線：採用PVC UL 183/18AWG材質
線長：1100±0mm
外徑：4mm
額定溫度：-45°~105°
絞銅芯線：170芯/0.08mm
- 連接座：
角度呈105°
被覆式鍍鎳的4mm香蕉插頭
- 安全規範：
IEC/EN 61010-031
CAT III 1000V 15A(170芯/0.08mm) / CAT IV 1000V 15A(200芯/0.08mm)



TEL-AL11-1



TEL-AL11-2A



TEL-AL11-3



TEL-AL11-4



TEL-AL11-5

AL-37S



CE

- 尾端各有被覆式插頭
- PVC絕緣線，長50公分(170芯/0.08mm)
- 後端可搭接4mm香蕉插頭
- 安全規範：IEC/EN 61010-031 CAT III 600V 10A

AL-39



- 兩端各為被覆式插頭
 - 矽膠線為1.2公尺
- AL-39R(紅色)**
AL-39B(黑色)

AL-39H

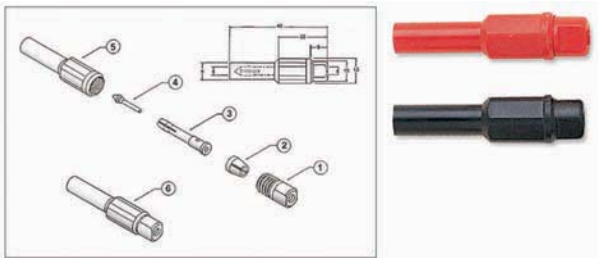

- 被覆式插頭
- AL-39HR(紅色)**
AL-39HB(黑色)

AL-50



- 被覆式4mm的香蕉插頭，棒體容易把握使用
 - 特殊的矽膠絕緣線長2.7公尺
 - 綠色線為接地線，保障人體安全
 - 顏色：紅色
- ※ 注意
輸入：最大為交流(AC)1000V
輸出：最大為直流(DC)10KV，3W
只適合在高壓阻抗計(絕緣表)量測用

AL-51

NEW



- 連接座：4mm的香蕉插頭
- 線：PVC UL1803 180芯/0.12mm
長度：1100±30mm
外徑：4mm
額定溫度：-45°~105°
- 安全規範：IEC/EN 61010-031 CAT IV 1000V 15A

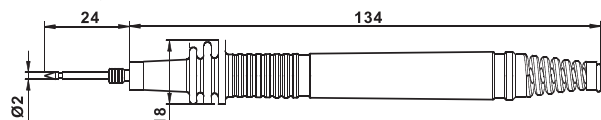

AL-52F系列

NEW



CE

- 內縮式的透明被覆蓋
- 探針：有2mm和4mm兩種
- 線：PVC UL1803
線長：1100±30mm
外徑：4mm
絞銅芯線：170芯/0.08mm
額定溫度：-40°~105°
- 有保險絲保護設計，尺寸為6 x 32mm
- 安全規範：EN61010-031 CAT IV 600V 10A

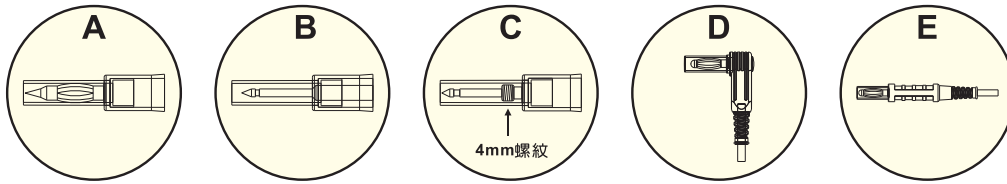
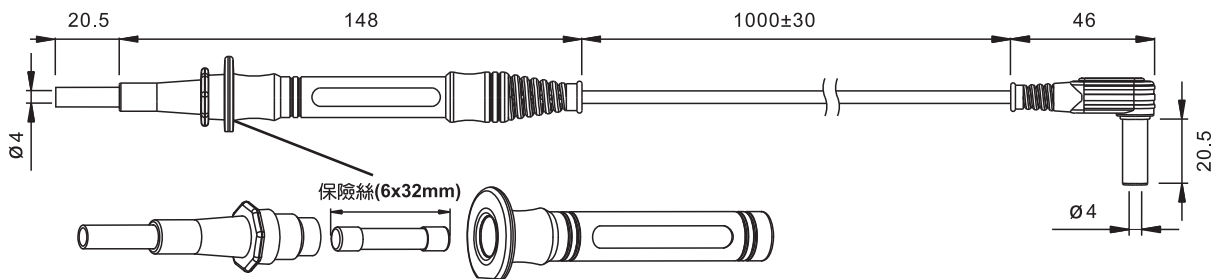

型號	探針	連接座	線長(1100±30mm)	保險絲(6 x 32mm)
AL52F-L4	A	D	✓	✓
AL52F-L2	B	D	✓	✓
AL52F-L2-4	C	D	✓	✓
AL52F-I4	A	E	✓	✓
AL52F-I2	B	E	✓	✓
AL52F-I2-4	C	E	✓	✓

AL-55



放電棒

- 作供絕緣阻抗計快速放電之用
- 內縮的被覆式4mm香蕉插頭，棒體方便把握量測
- 特殊的絕緣矽膠線，線長1.5公尺
- 顏色：黑色

TEL-AL11-6A



- 連接座：4mm的香蕉插頭
- 線：PVC UL1803
長度：1100±30mm
外徑：4mm
絞銅芯線：200芯/0.08mm
額定溫度：-40°~105°
- 顏色：紅、黑各一條
- 安全規範：IEC/EN 61010-031 CAT IV 1000V 10A

TEL-AL11-7A



- 連接座：4mm的香蕉插頭
- 線：PVC UL1803
長度：1100±30mm
外徑：4mm
絞銅芯線：200芯/0.08mm
額定溫度：-40°~105°
- 顏色：紅、綠、黑

TEL-4136C

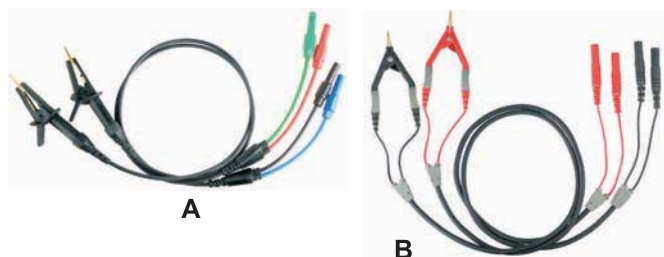

凱文式測試線

- 線：PVC絕緣線
(連接插頭部分為10公分的絕緣矽膠線)
線長：700±30mm
外徑：4mm
- 插頭及矽膠線分紅、綠、黑、藍四種顏色

TEL-EWR-50F



- 供量測接地阻抗連結輔助接地棒用
- 連接座：4mm銅質香蕉插頭
- 線：PVC絕緣軟線
長度：50公尺
外徑：4mm
絞銅芯線：30芯/0.254mm
顏色：綠
- 附件：輔助接地棒1支，鱷魚夾1個



STANDARD

測試線(Test Leads)

AL-4WER



- 供四線式量測接地阻抗用
- 連接座：4mm銅質香蕉插頭
- 線：PVC絕緣線
外徑：35mm
絞銅芯線：65芯/0.127mm
長度：黑：3公尺·藍：20公尺·紅：36公尺·綠：50公尺
- 接地棒：長45公分

TEL-EL

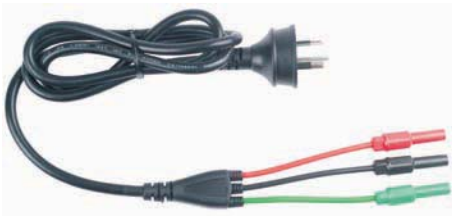

- 供斷路器檢測計量測用



STANDARD

測試線(Test Leads)

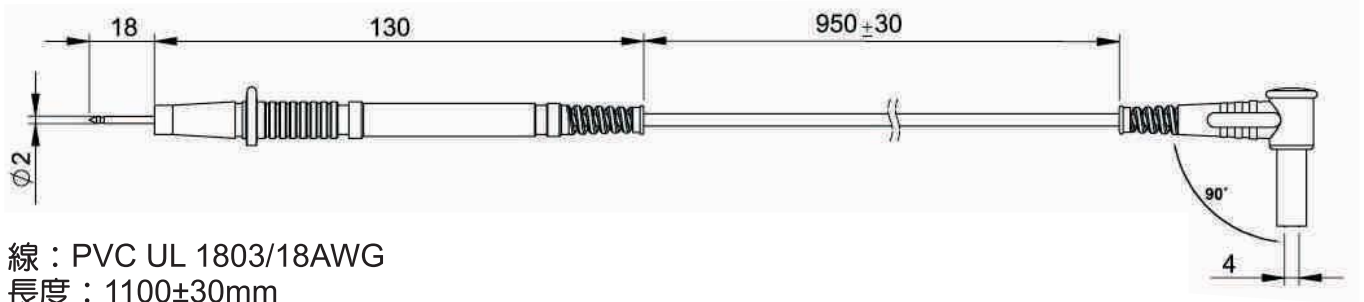

- 線：PVC UL 1803/18AWG
長度：1100±30mm
外徑：4mm
額定溫度：-45°~105°
絞銅線：170芯/0.08mm
- 連接座，被覆式，4mm銅質鍍鎳
- 安全規範：
IEC/EN 61010-031 CAT IV 1000V 10A





STANDARD

測試線(Test Leads)

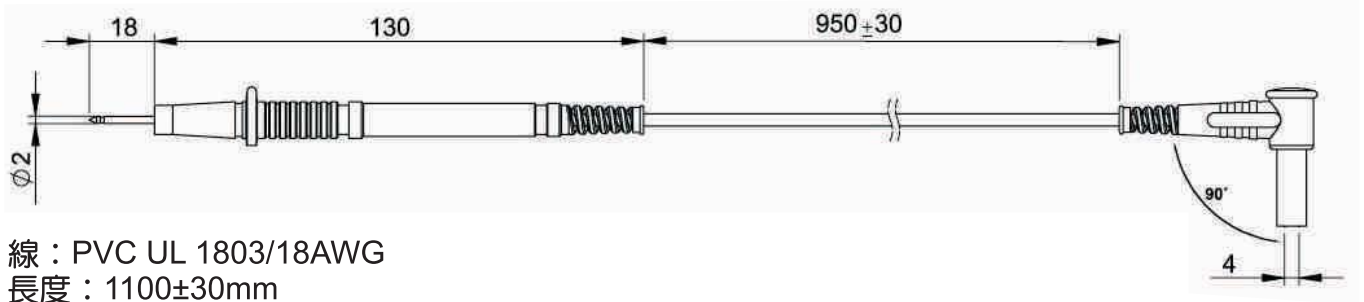

- 線：PVC UL 1803/18AWG
長度：1100±30mm
外徑：3.5mm
額定溫度：-45°~105°
絞銅線：64芯/0.12mm
- 探針：
4mm鍍金：AL-24A(AL-24不含鱷魚夾)
4mm鍍鎳：AL-25A(AL-25不含鱷魚夾)
2mm鍍金：AL-26
- 連接座：
90°角，4mm鍍鎳香蕉插頭，被覆式
- 安全規範：
IEC/EN61010-031
CAT III 1000V 10A / CAT IV 600V 10A



CE

AL-24A



CE

AL-25A



CE

AL-26



STANDARD

測試線(Test Leads)

AL-30, AL-30F



- 探針：有內縮式保護套設計，4mm鍍鎳香蕉插頭
- 雙重絕緣的矽膠線，長度為1公尺
- 安全規範：IEC/EN 61010-031 CAT III 1000V 10A

AL-30R(紅色)

AL-30B(黑色)

AL-30G(綠色)

<AL-30F> (測棒內有保險絲設計)

- 保險絲尺寸：6 x 32mm · 6 x 46mm

AL-30FR(紅色)

AL-30FB(黑色)

AL-30A

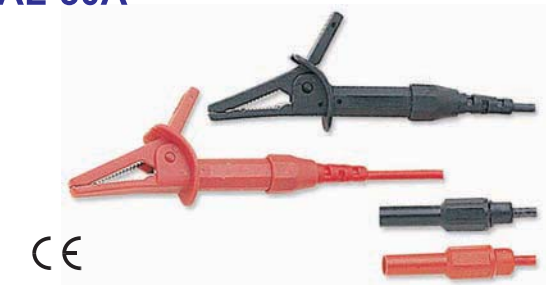

- 最大開口35公厘
- 雙重絕緣的矽膠線，長度為1公尺
- 安全規範：IEC/EN 61010-031 CAT III 1000V 10A

AL-30AR(紅色)

AL-30BA(黑色)

AL-30AG(綠色)

AL-32, AL-32F



- 探針：2mm，內縮式的護套
- 雙層絕緣的矽膠線，長度為1公尺

AL-32R (紅色)

AL-32B (黑色)

<AL-32F >

- 保險絲尺寸：6 x 32mm · 6 x 46mm

AL-33



- 最大開口35mm，強而有力的彈簧
- PVC線，長度1公尺

AL-34



- 最大開口35mm
- PVC線，長度60公分(65芯/0.127mm)
- 90°的连接座
- 顏色：紅、白、黑、藍、黃、綠
- 安全規範：
EN61010-031 CAT III 600V 10A

AL-35, AL-35F



- 探針：內縮式保護套
- 雙重絕緣的矽膠線
- 連接座呈90°角

AL-35R(紅色)

AL-35FB(黑色)

<AL-35F>

- 保險絲尺寸：6 x 32mm 6 x 46mm

AL-35FR (紅色)

AL-35FB (黑色)

AL-36



CE

- 鱷魚夾最大開口35mm，強而有力的彈簧
- PVC絕緣線：紅色-15公尺，黃色-10公尺，綠色-5公尺
- 90°的連接座
- 安全規範：EN61010-031 CAT III 600V 2A

AL-36R(紅色)

AL-36Y(黃色)

AL-36G(綠色)

AL-36L



- 鱷魚夾最大開口35mm，強而有力的彈簧
- PVC絕緣線：紅色-30公尺·黃色-20公尺·綠色-5公尺
- 90°的連接座

AL-37



- 尾端各有被覆式插頭
- 線為矽膠線，長為50公分
- 連接座後方可搭接4mm的香蕉插頭

AL-37R(紅色)

AL-37B(黑色)

AL-37G(綠色)

AL-37H

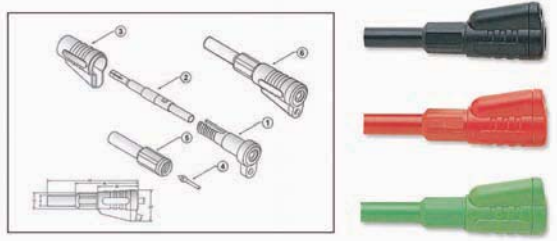

- 被覆式的插頭
- 連接座後方可搭接4mm的香蕉插頭